

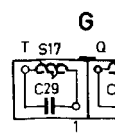

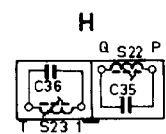

|   |                         |   |  |   |
|---|-------------------------|---|--|---|
| S | 31. 32. 33. 28. 29. 30. | K. 41.                                  | 42.  | H. J.                                   |
| C | 77. 76.                 | 60. 61. 70. 62. 82. 84. 80. 81. 74. 65. | 3. 66. 64. 67. 68. 63. 48. 78. 49. 52. 83. 71. 75. 69. 74. 76. 45. | 42. 40. 41. 39. 37.                     |
| R |                         | 33. 34. 35. 36. 37. 38. 41. 65. 64.     | 57. 45. 59. 39. 51. 40.  | 55. 42. 50. 19. 56. 58. 52. 62. 54. 14. |
| R |                         | 53. 63.                                 | 61. 48. 47. 49.  | 18. 16. 46. 60. 17.                     |

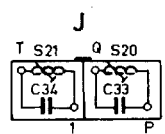
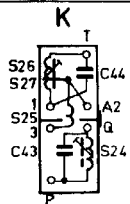
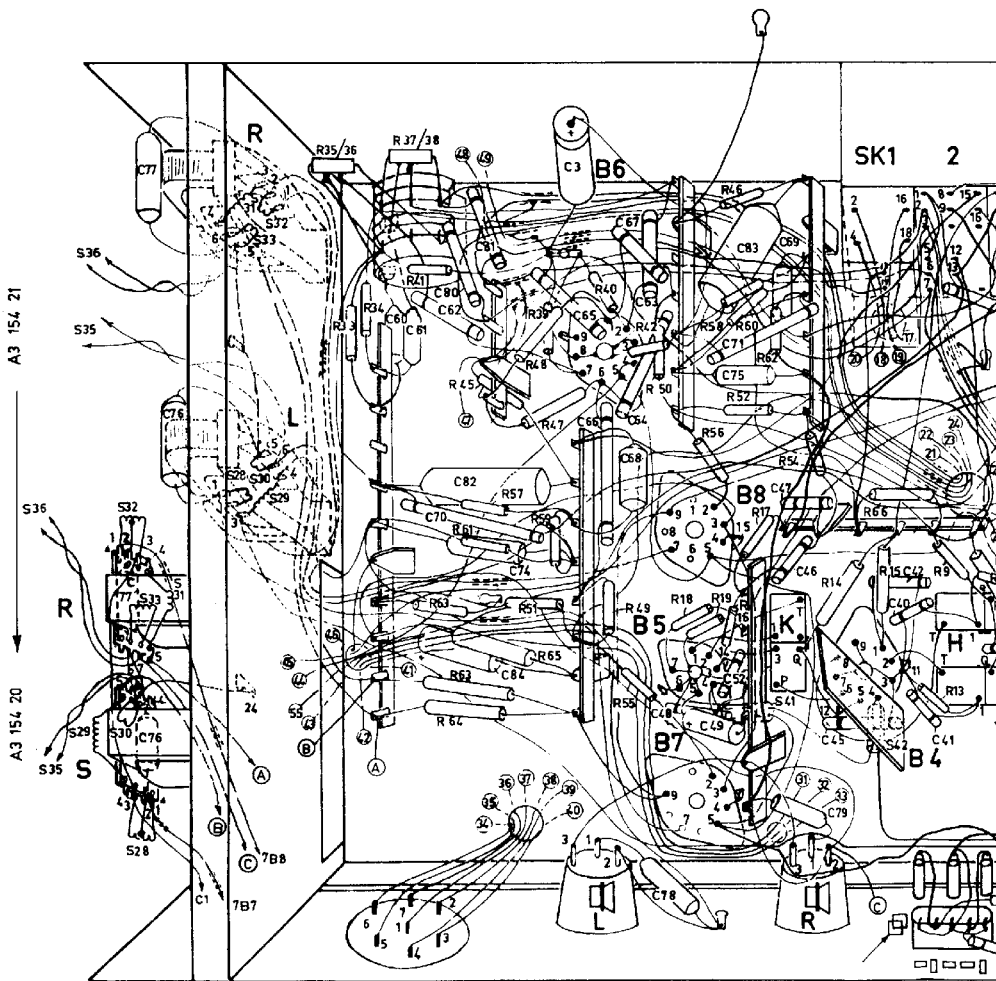

|            |  |         |                        |           |
|------------|--|---------|------------------------|-----------|
| H. J.      | E.   | D.      | F. G. C. 40.           | 9. B. A.  |
| 1. 39. 37. | 9. 23. 22. 13. 38. 24. 21. 25. 18. 19. 20. 50. 16. 32. 17. | 5. 4.   | 1. 2. 11. 12. 7. 8. 6. | 10. 53.   |
| 11. 10.    | 30. 43. 12. 8. 5.  | 44. 31. | 4. 3. 7.               | 2. 20. 1. |
| 74. 75.    |  |         |                        |           |

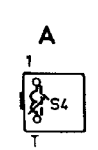
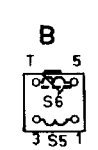
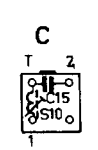
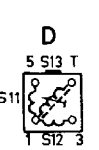
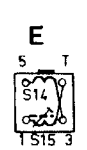
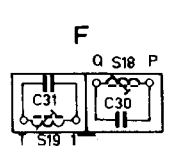
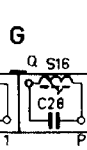
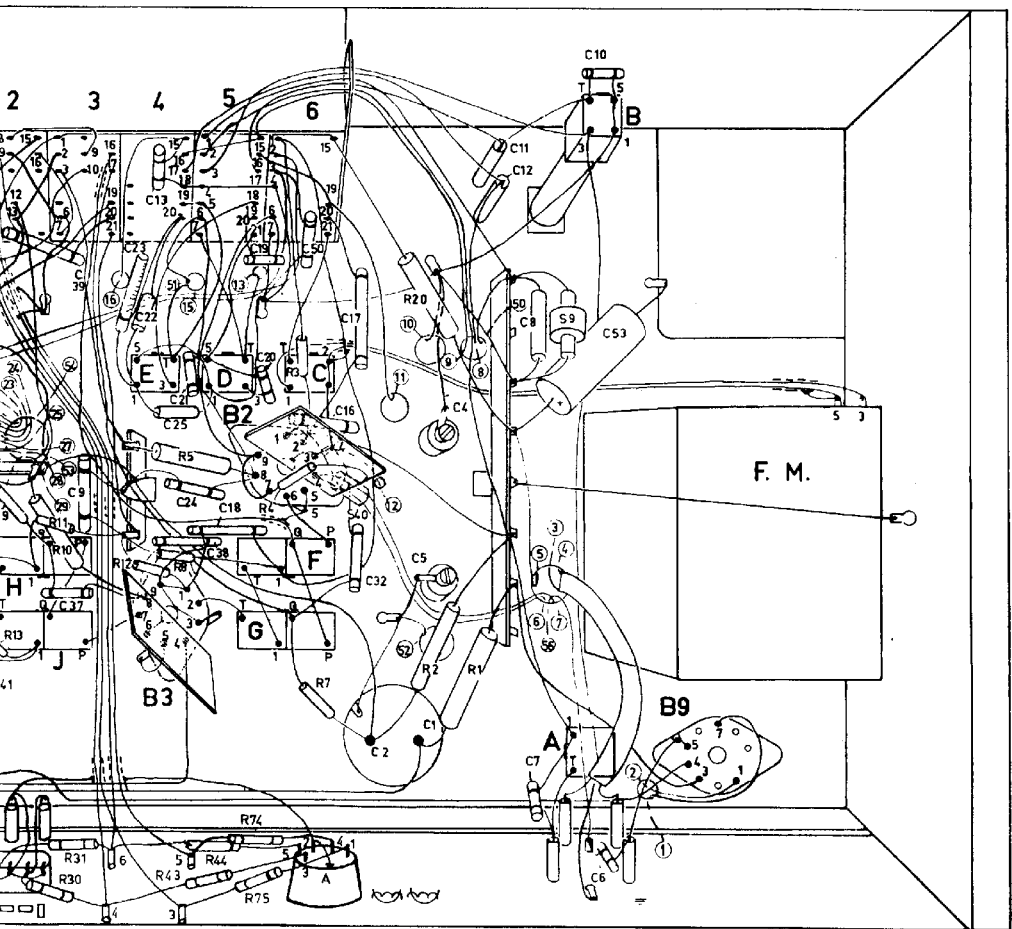

R 196 97 A

|   |                  |               |                |             |                            |                                   |
|---|------------------|---------------|----------------|-------------|----------------------------|-----------------------------------|
| S | 50 51 52 53 54 4 | 5 7 8 9 6 5 8 | 57 55 56 10    | 60 59       | 13 15 12 14 11 16 18 17 19 | 20 22 21 23                       |
| C | 6 8 07 81 84     | 8             | 10 12 13 11 14 | 15 16 17 18 | 21 19 24 32 26 20 28       | 29 33 35 34 36 41                 |
| C | 82 85 83         | 94            | 95 90 91       | 87 92 93    | 96 88 86 89 98 97          | 53 5 22 23 25 27 30 31 37 38 40 9 |
| R |                  | 60            | 61 62          | 2 3         | 63 4 5 25                  | 7 8 10 9 11 12 13                 |

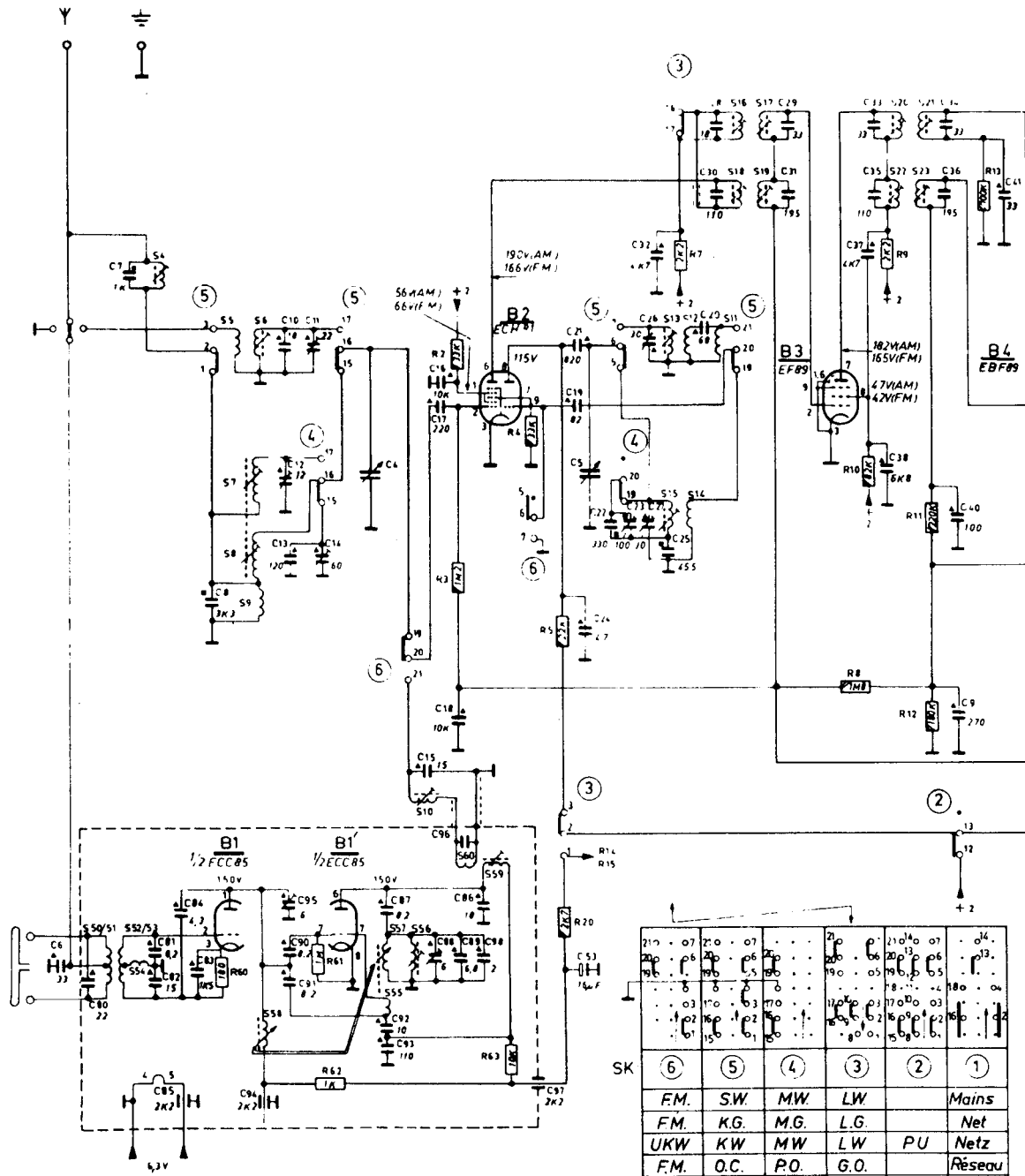

|     |      |      |      |      |     |        |    |     |    |
|-----|------|------|------|------|-----|--------|----|-----|----|
| 210 | 07   | 210  | 07   | 210  | 07  | 210    | 07 | 210 | 07 |
| 200 | 06   | 190  | 05   | 180  | 04  | 170    | 03 | 160 | 02 |
| 150 | 01   | 140  | 00   | 130  | 99  | 120    | 98 | 110 | 97 |
| 100 | 96   | 90   | 95   | 80   | 94  | 70     | 93 | 50  | 92 |
| 60  | 91   | 50   | 90   | 40   | 89  | 30     | 88 | 20  | 87 |
| 10  | 86   | 0    | 85   | 0    | 84  | 0      | 83 | 0   | 82 |
| SK  | (6)  | (5)  | (4)  | (3)  | (2) | (1)    |    |     |    |
|     | FM.  | SW.  | MW.  | LW.  |     | Mains  |    |     |    |
|     | FM.  | KG.  | M.G. | L.G. |     | Net    |    |     |    |
|     | UKW. | KW.  | MW.  | LW.  | PU  | Netz   |    |     |    |
|     | FM.  | O.C. | P.O. | G.O. |     | Réseau |    |     |    |
|     | FM.  | O.C. | O.M. | O.L. |     | Red    |    |     |    |

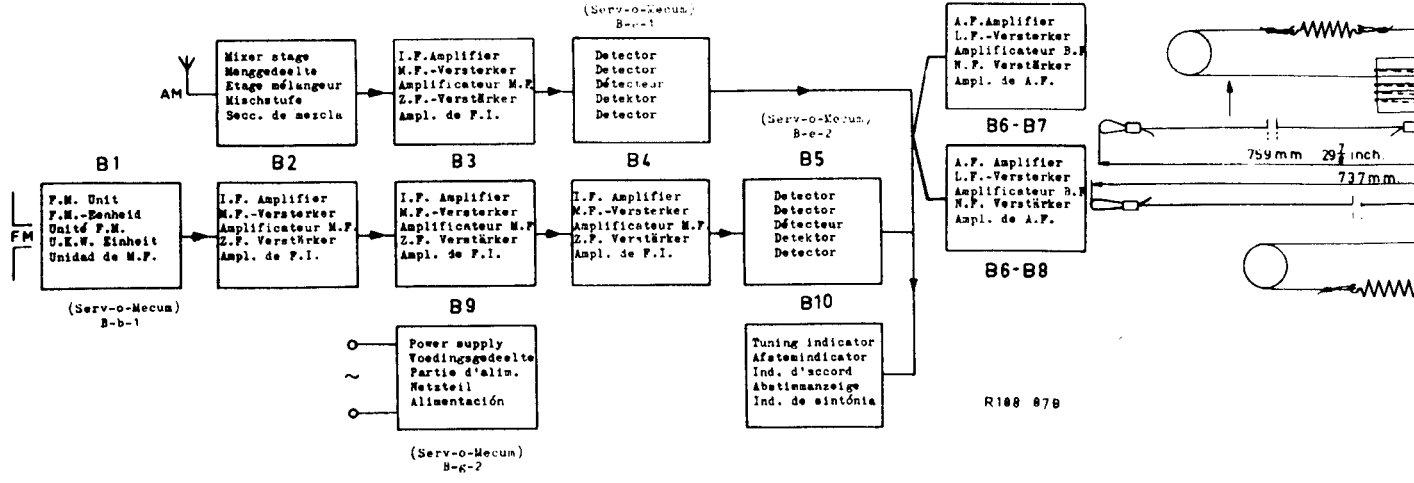

R188 87B



